

Tools

Philips Screwdriver



Allen Key (supplied)



Check List

Familiarise yourself with the contents



Check there is nothing missing



Check you have all the tools required



Make room to assemble the product



Assembly Instructions

3 SHELF MAPLE BOOKCASE A4

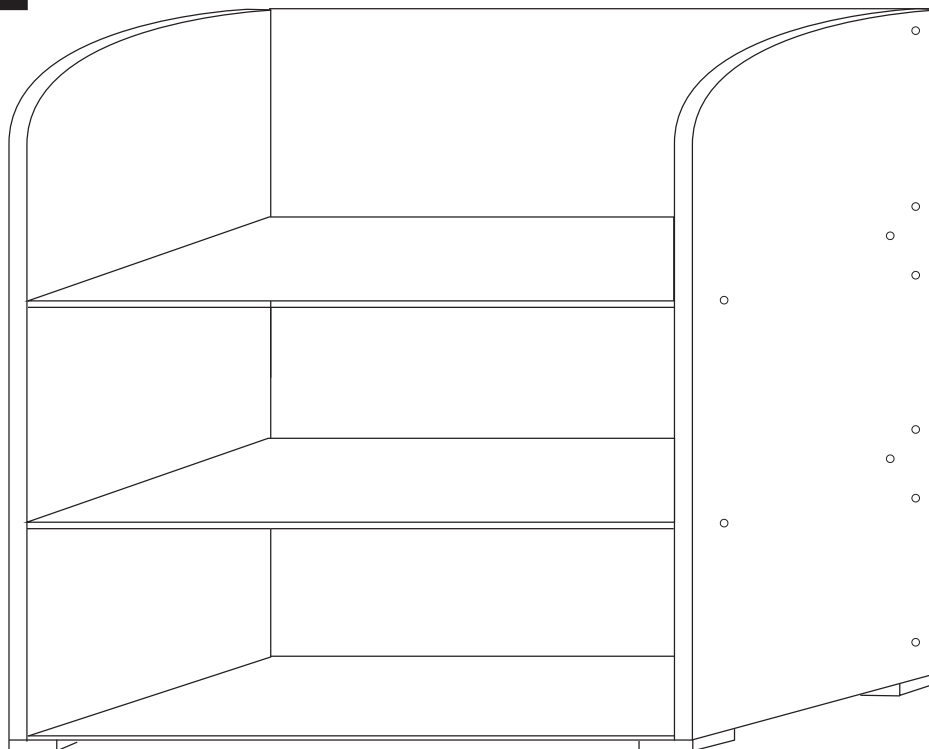

Code: A4MAP3

Before starting to assemble this unit please read the step by step assembly instructions carefully.





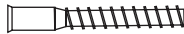

**Contact Number
0151 479 3030**

Profile Education

Components		Quantity
Confirmat Screws		25
4 x 25 screws		16
Feet		4
Allen Key		1

Contact Number
0151 479 3030

Panels	Quantity	Size (mm)
 ENDSA	2	950x340mm
 SHELVES B	2	1065x330mm
 BOTTOM C	1	1109x347mm
 BACKS D	2	1065x307mm
 BACK E	1	1065x300mm

IMPORTANT Panels lettered for identification if spare part is required.
Please also state colour.

Contact Number
0151 479 3030

Profile Education

Step 1

Secure (4) Feet to Bottom C using (16) 4 x 25 screws. Use pop marks provided.

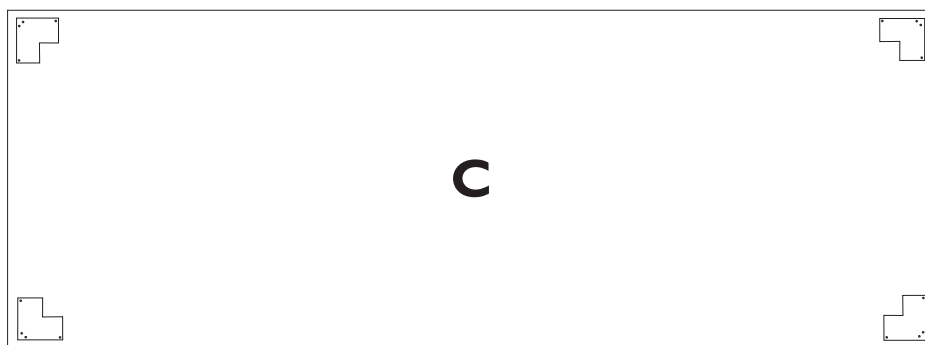

Contact Number
0151 479 3030

Step 2

Secure (1) Back D to (1) End A using (2) Confirmat Screws.

Secure (1) Back B to (1) End A using (2) Confirmat Screws.

Secure (1) Back D to (1) End A using (2) Confirmat Screws.

Secure (1) Back B to (1) End A using (2) Confirmat Screws.

Secure (1) Back E to (1) End A using (2) Confirmat Screws.

Secure (1) End A to Backs D Shelves B and Back E using (10) Confirmat Screws.

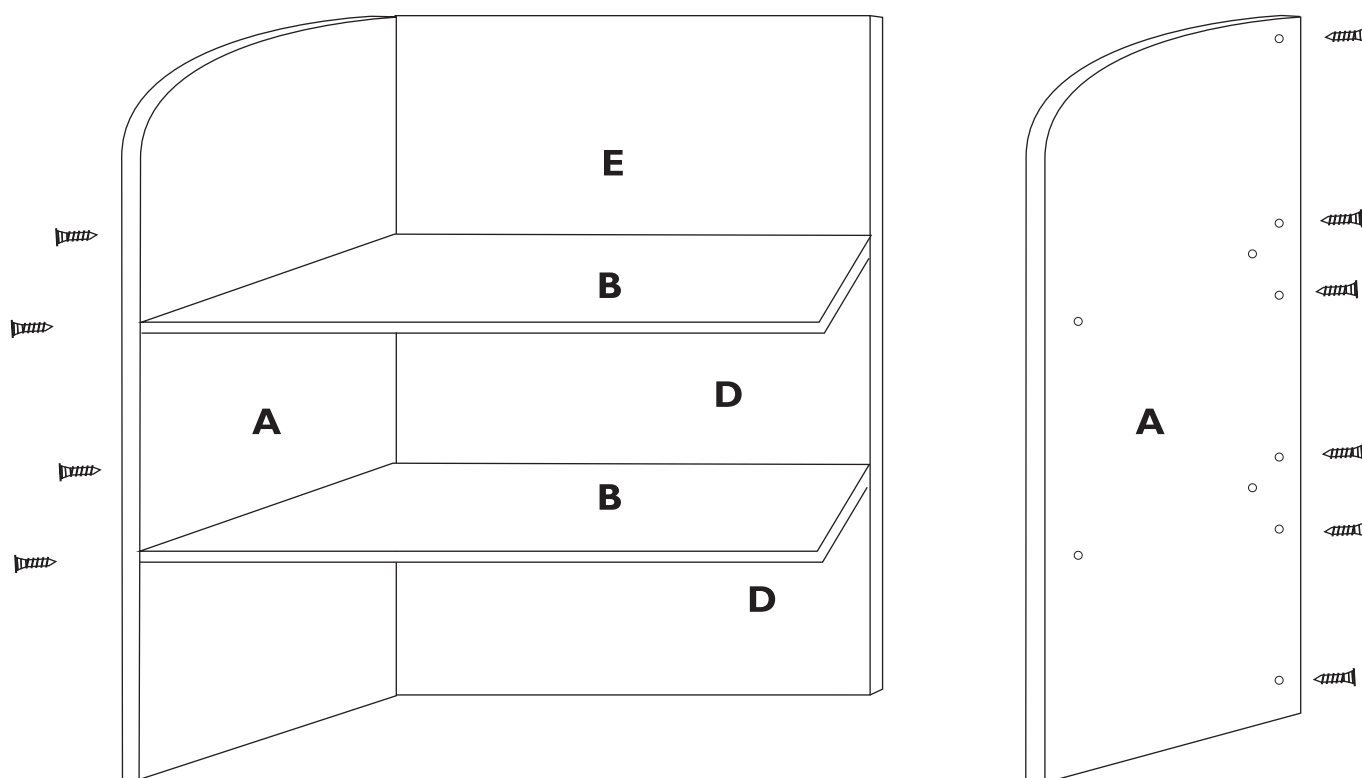

Contact Number
0151 479 3030

Step 3

Secure (1) Bottom C to Ends A using (5) Confirmat Screws.

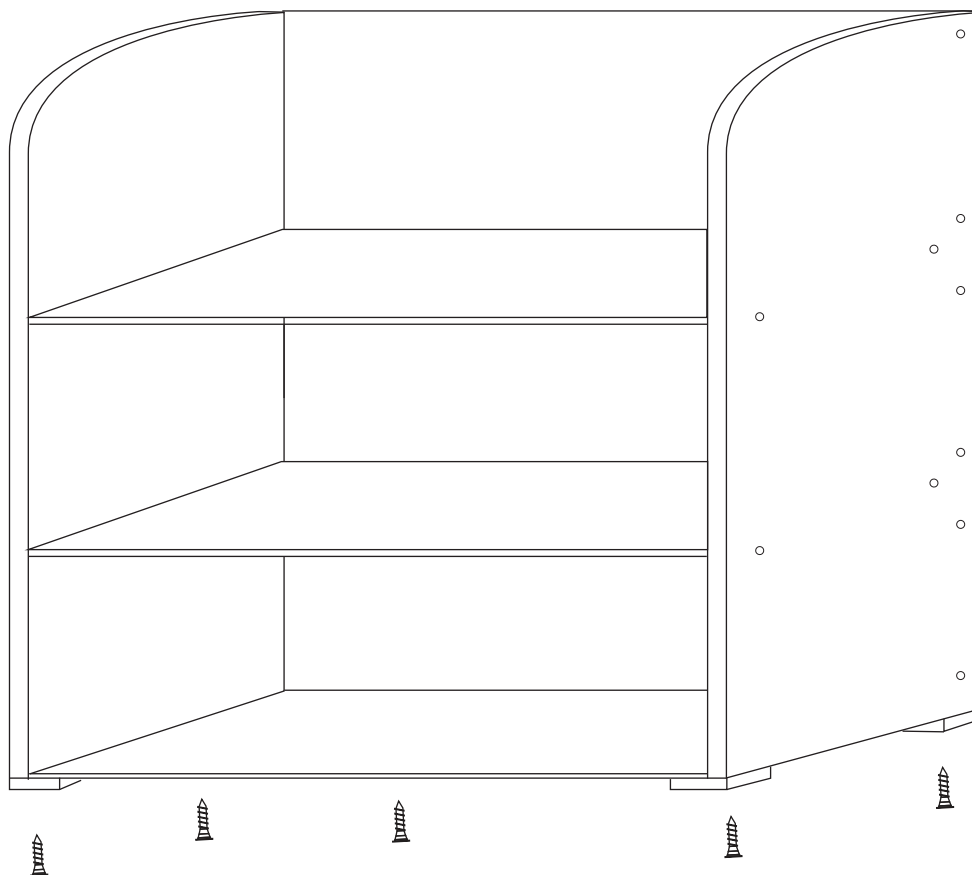

YOUR UNIT IS NOW COMPLETE

**Contact Number
0151 479 3030**