

**Tools**

Philips Screwdriver



Allen Key (supplied)



**Check List**

Familiarise yourself with the contents



Check there is nothing missing



Check you have all the tools required



Make room to assemble the product



# Assembly Instructions

**12 SECTION LITERATURE ORGANISER**

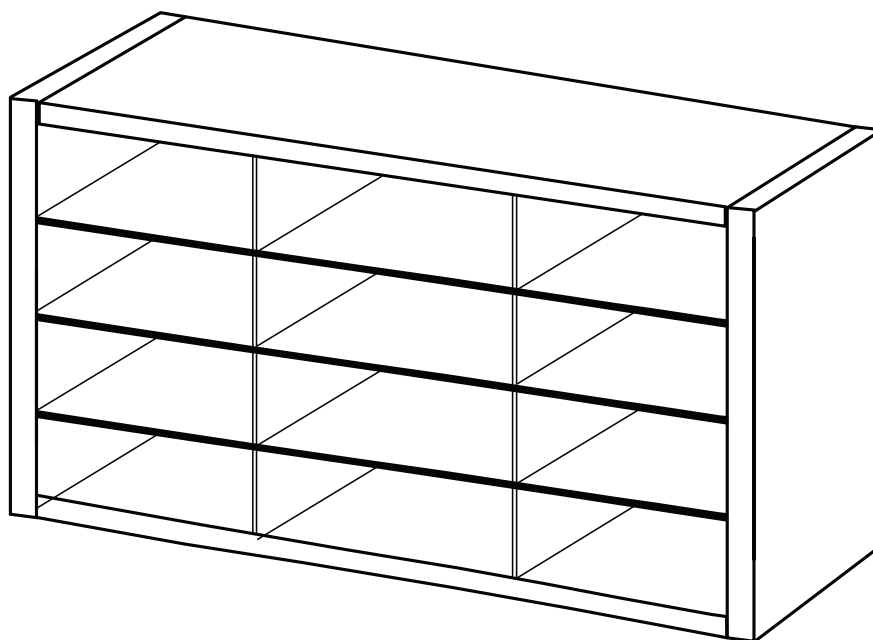

**Code: AB444**

**Before starting to assemble this unit please read the step by step assembly instructions carefully.**

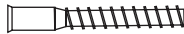

**Contact Number  
0151 479 3030**

# Profile Education

Components		Quantity
Confirmat Screws		12
Screw Caps		12
Trims		3
3/4" Nails		40
Allen Key		1

Panels	Quantity	Size (mm)
	2	312x300mm
	2	704x300mm
	1	725x305mm

Contact Number  
**0151 479 3030**

## Step 1

Secure ends A to top and bottom using (12) Confirmat Screws.

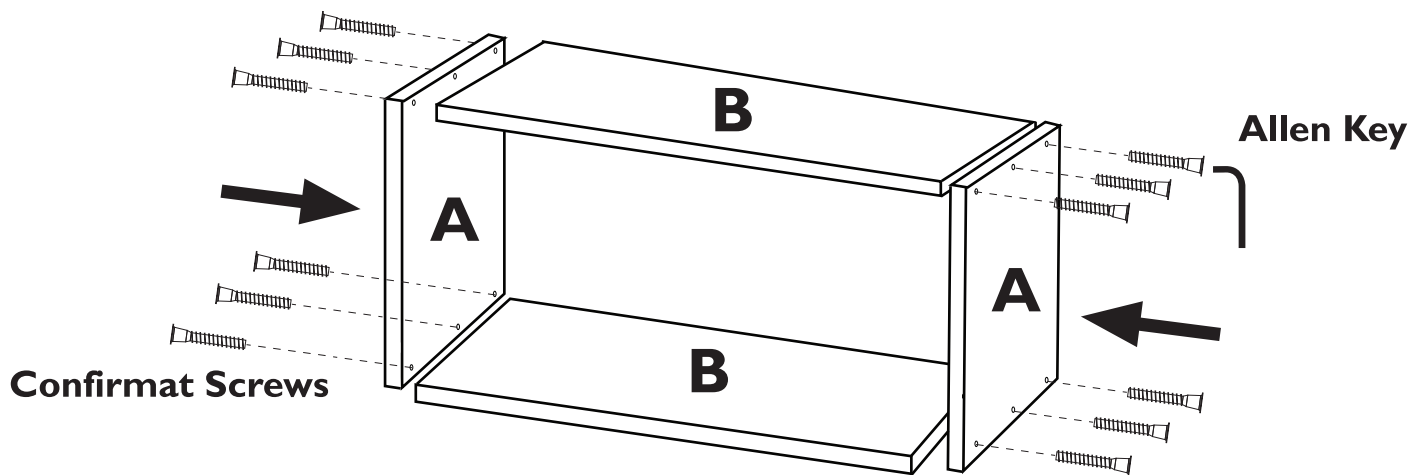

## Step 2

Slot cardboard partitions together as shown.

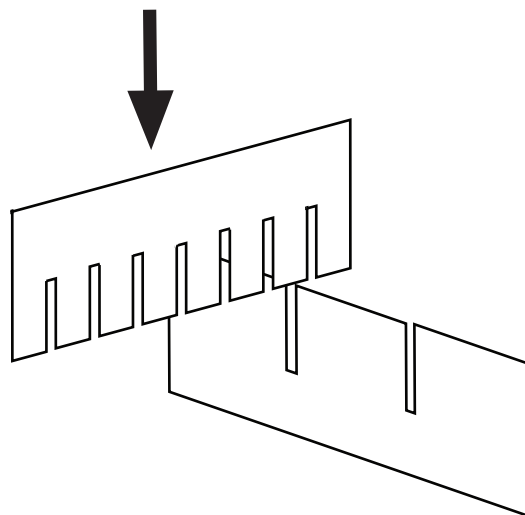

Contact Number  
**0151 479 3030**

## Step 3

Position end partitions - flex partition 'tails' inwards.

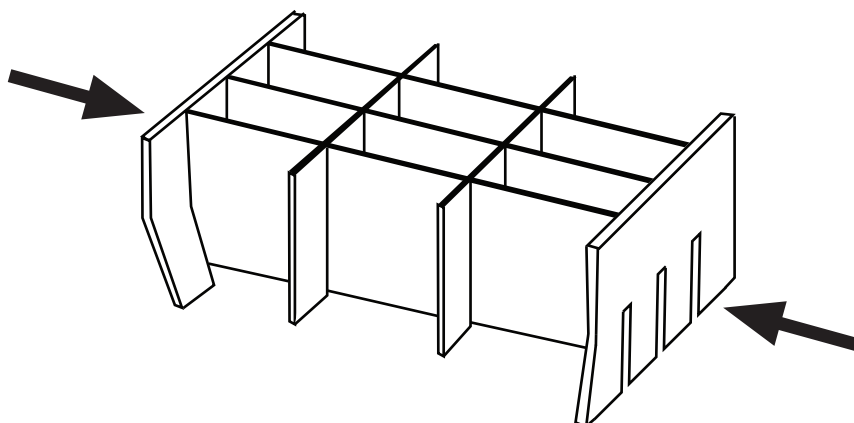

## Step 4

Position unit face up on floor. Lower partition assembly into the unit and slide a channel on to partition before partition is flush with ends.

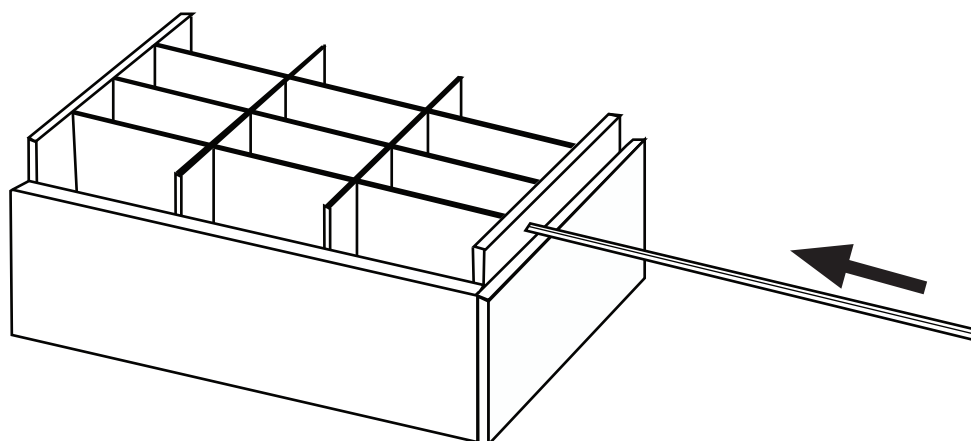

Contact Number  
**0151 479 3030**

## Step 5

Carefully turn unit over. Position back panels as shown and secure with nails.

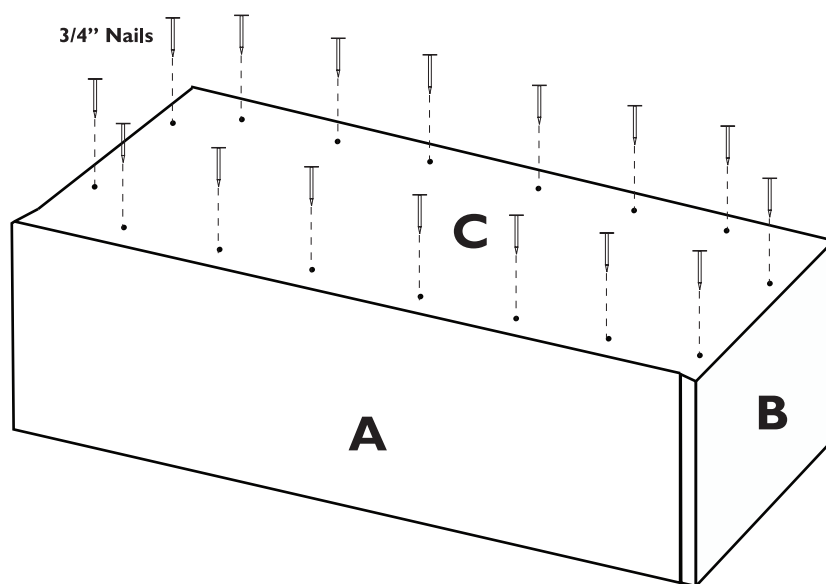

Contact Number  
**0151 479 3030**